

結繩參考圖說

平結：

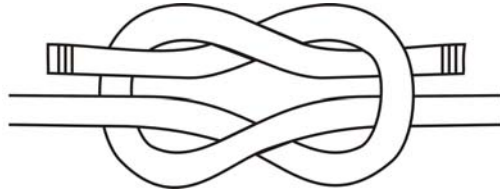

接繩結：

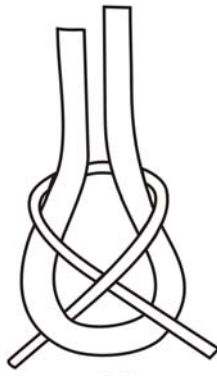

雙套結：

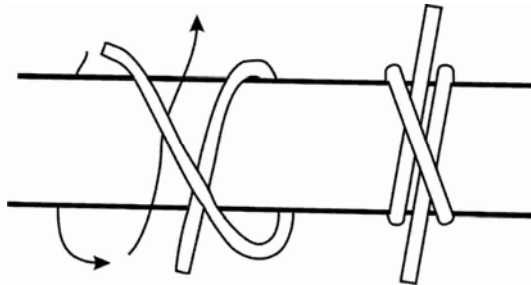

稱人結：



鞞韃結：

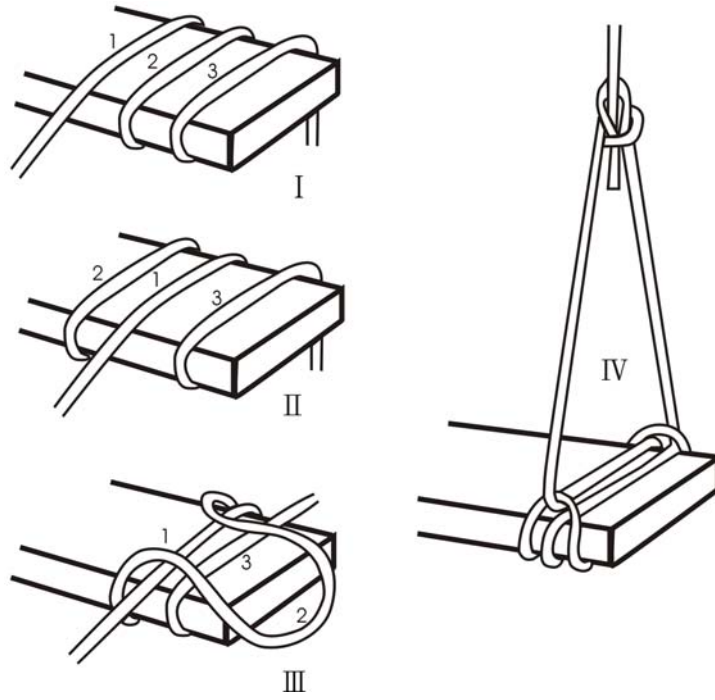

縮短結：

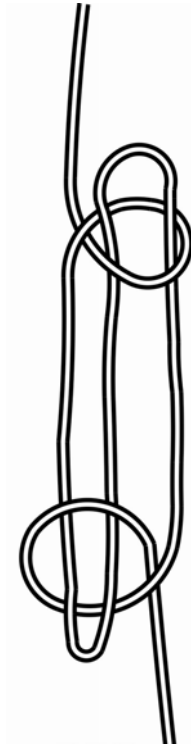

活索結：

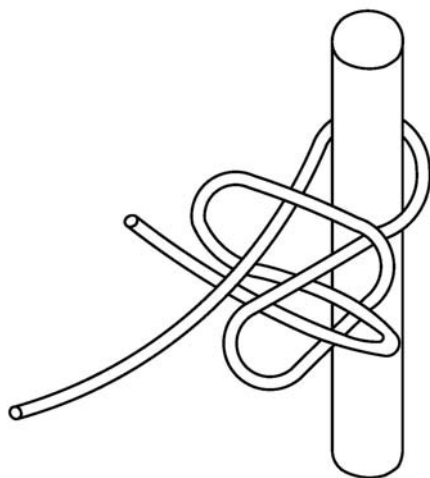

牧童結：

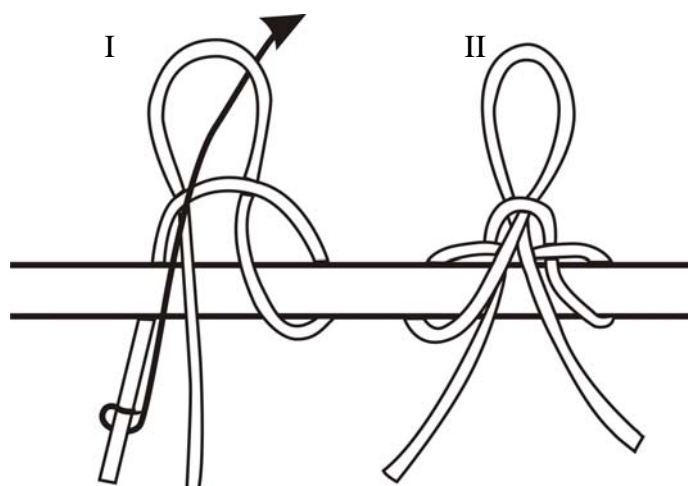

瓶口結：

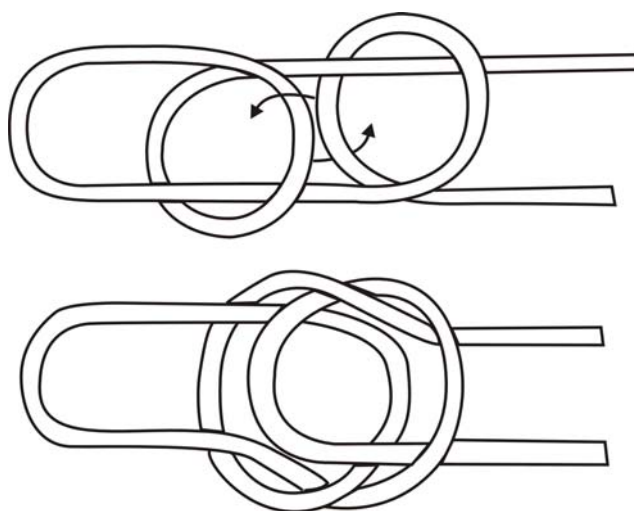

袋口結：

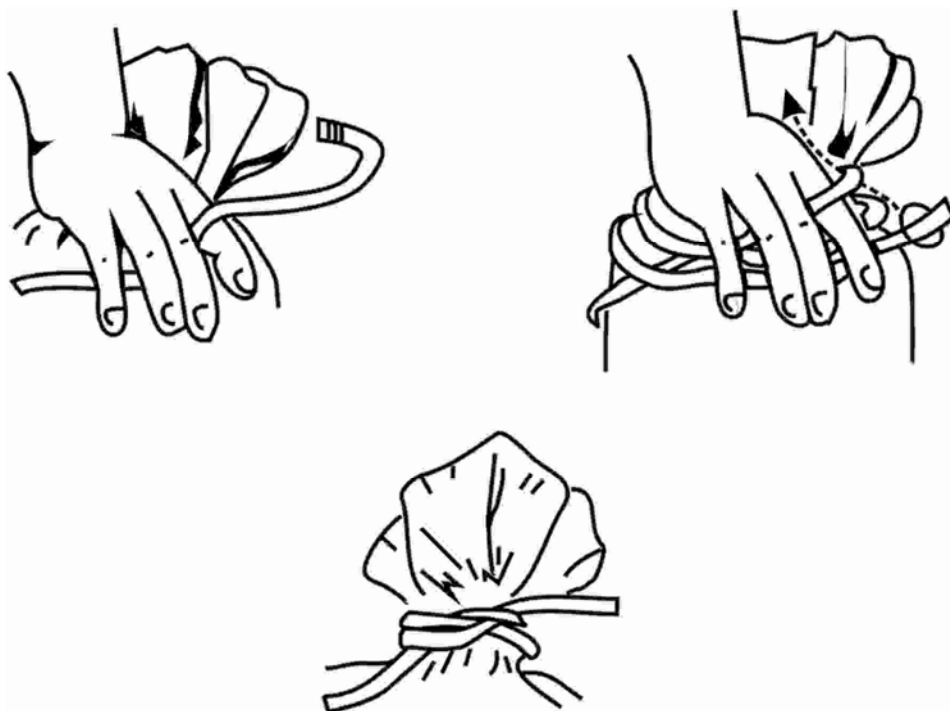

營繩結：

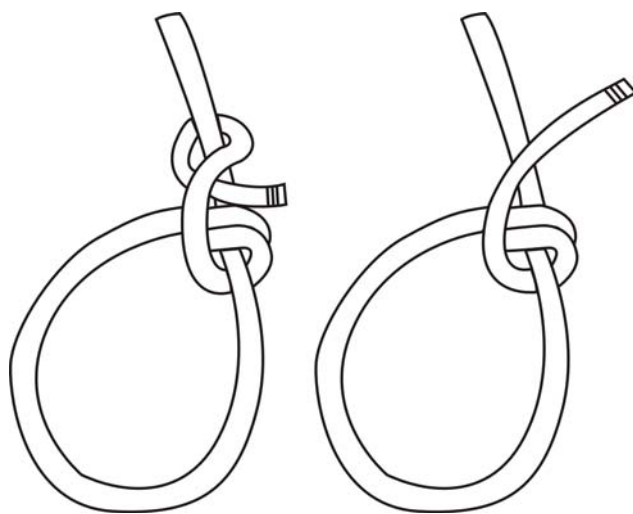

繫木結：

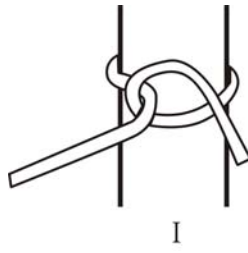

I

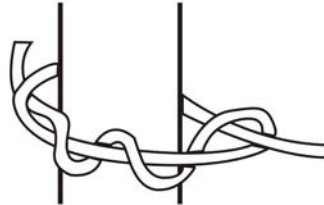

II

棍頭結

打在棍頭上，至少纏繞十圈

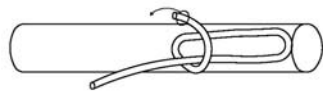

I

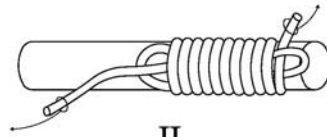

II

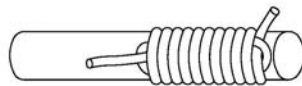

III

三套結：

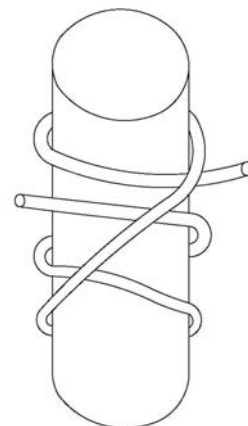
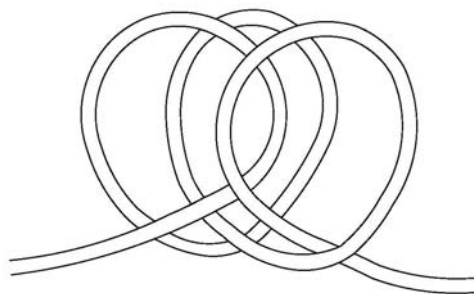

花聯結：

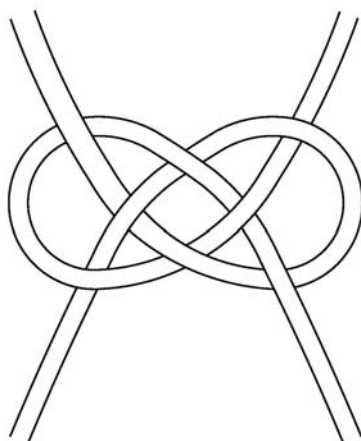

椅結：

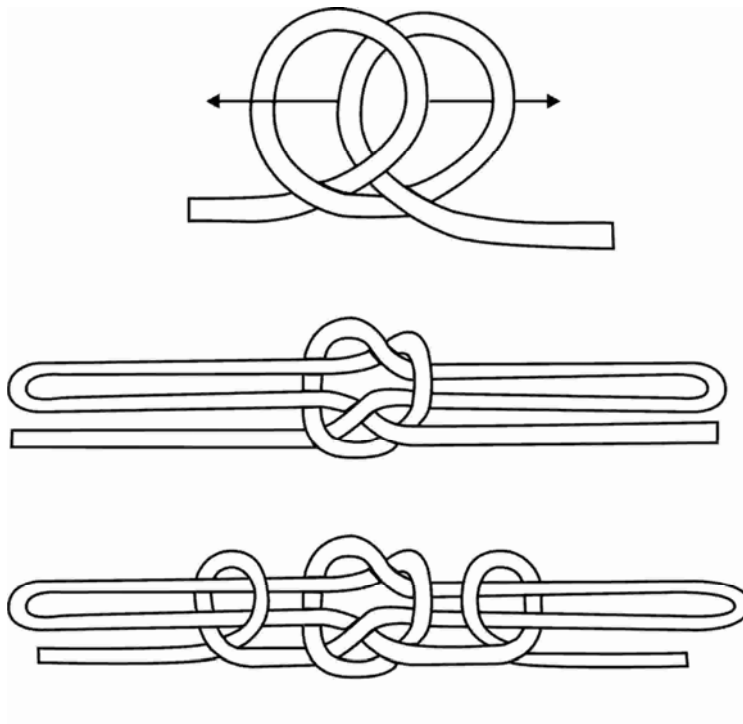

漁人結：

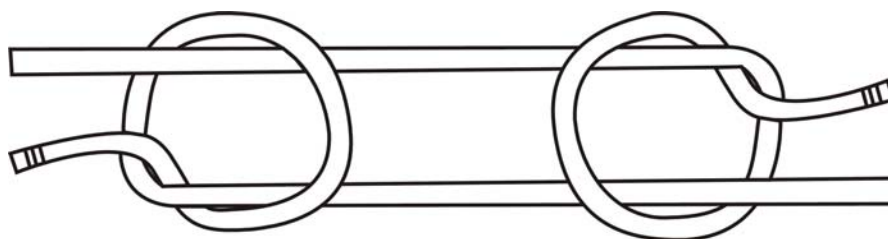

槓桿結：

